

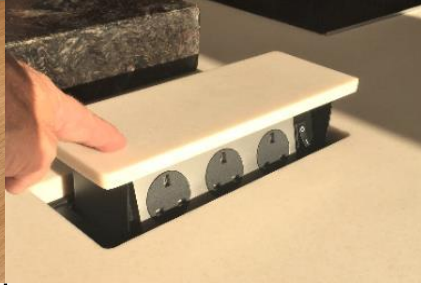

S-BOX™

CHAMELEON



2-PORT MINI

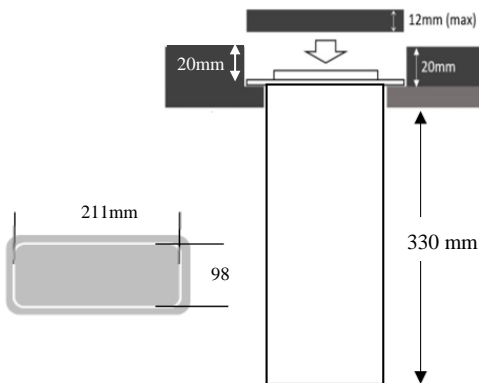

3-PORT

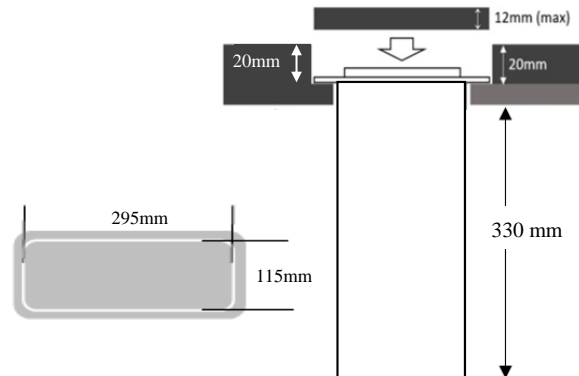

WORKTOP CUTTING INSTRUCTIONS . . pages 2-10
SITE INSTALLATION INSTRUCTIONS . . pages 11-12

The S-Box™ Chameleon Models are specifically designed for installation at exactly -20mm below surface - for an invisible and camouflaged location in the Counter.

This enables pop-up sockets to remain hidden from view until they are required!

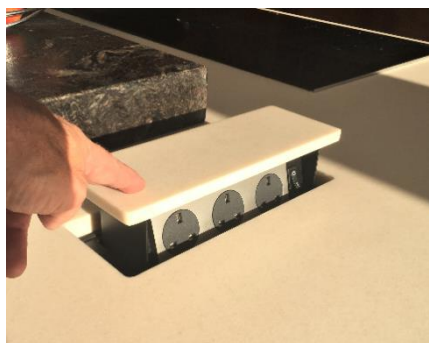

All S-Box™ Chameleon units drop into position from above. No fixings required. They are SOLID STEEL ENGINEERING.

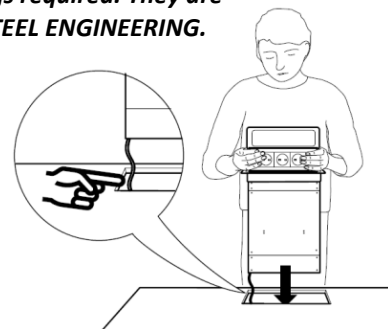

This method involves:

1. The installation of the main structure at exactly 20mm below the Counter-top on a rebate, so that the product can then receive its custom top – one that is therefore flush with, and matching with, its surroundings.
2. The creation of a Custom Top (12mm maximum) to place on the unit itself.

In worktop materials of 30mm thickness and above, the installation is achieved by sitting the unit's collar on a **true rebate** cut **within** the material itself.

For materials of 20mm or 12mm thickness, installation is achieved by sitting the unit's collar on a **"false" rebate**. This is created by using a second/slave material immediately below.

SEE THRU-VIEWS and EXAMPLES BELOW (NB. REBATE IS ALWAYS 20mm)

TRUE REBATE IN 30mm MATERIAL

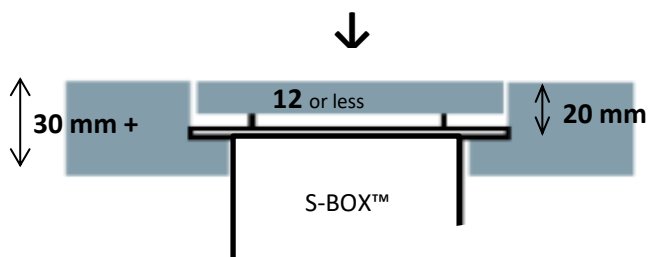

Rebate in 30mm GRANITE or QUARTZ



FALSE REBATE IN 20 or 12mm MATERIAL

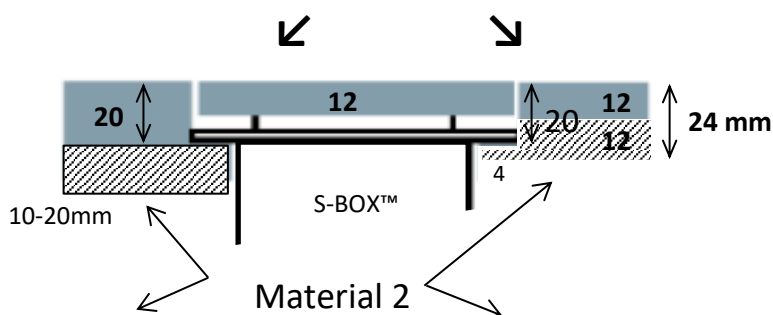

Material 2 bonded underneath



False Rebate using 20mm QUARTZ



Rebate using 12 + 12mm CORIAN®



SO ANY S-BOX™ THAT IS TO BE INSTALLED IN THE HIDDEN “CHAMELEON” MODE, NEEDS THE INVOLVEMENT OF THE WORKTOP FABRICATOR AND HIS CUTTING TOOLS . . .



IN MATERIAL SUCH AS TIMBER, THIS CAN BE DONE BY HAND-TOOLS, BUT IN STONE MATERIAL (such as GRANITE/QUARTZ) AND IN MOST COMPOSITE MATERIALS, ALL PROCESSES ARE CARRIED OUT IN-FACTORY.

THIS IS THE SAME WAY THAT ANY STONE COUNTER IS PRE-CUT FOR THE SINK, THE TAPS, EXTRACTOR OR COOKER HOB.



THE CUTTING TOOLS (TYPICALLY CROSS-CUTTER and CNC ROUTER) ARE PROGRAMMED WITH THE DIMENSIONS REQUIRED.

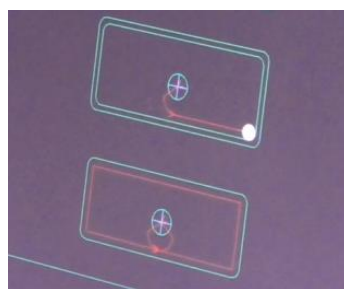

NB.
A ROUTER STARTS ITS CUTTING ROUTE FROM THE CENTRE POINT WHEN IT MACHINES OUT ANY HOLE.

In 20mm material (or less) the hole will only be a full thru-cut one, with the rebate added later by using a second material underneath)

In the case of 30+mm material, machining will also include making the rebate for an S-Box™.



TO CREATE THE REBATE IN 30mm MATERIAL – THE ROUTER CARRIES OUT TWO PROCESSES: THE FIRST IS A FULL THRU-CUT HOLE. THE SECOND IS TO GRIND OUT AN EXTRA 8mm, AT 20mm DEPTH. THE CUSTOM TOP DIMENSIONS ARE 3mm SMALLER, TO PRODUCE A 1.5MM GAP TO ALL 4 SIDES. (see 'custom top' process on page 10)

30mm



"TRUE" REBATE FOR INSTALLING AN S-BOX™ CHAMELEON UNIT IN 30mm COUNTER-TOP

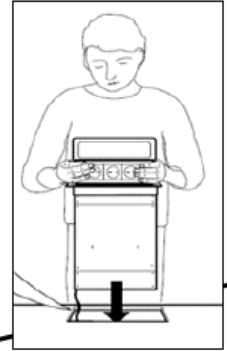

2-PORT MINI

KEY DIMENSIONS

NB. THIS DIAGRAM DOES NOT SHOW RADIUS CORNERS FROM CUTTING PROCESS OR TOOLS, BECAUSE THEY CAN BE ANY RADIUS PREFERRED. (as long as custom top fits inside radius of Cut-hole)



Matching thin stock or Sliced down from Offcut material ↓



CUSTOM TOP
10-12mm (MAX)

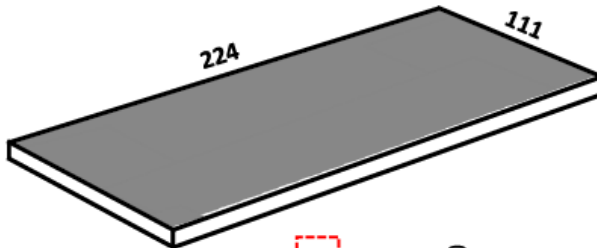

THRU CUT #1

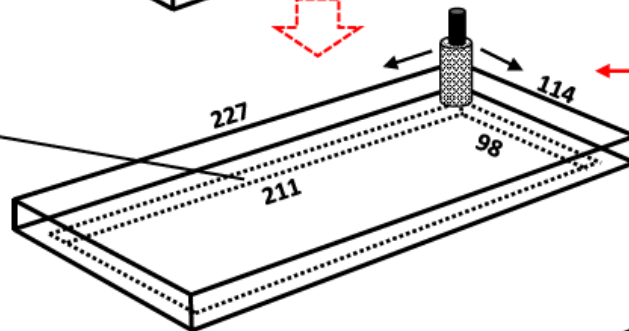

PLUS 8mm x 20mm ROUTED REBATE ALL ROUND

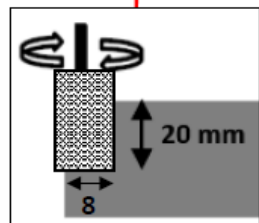

REBATE

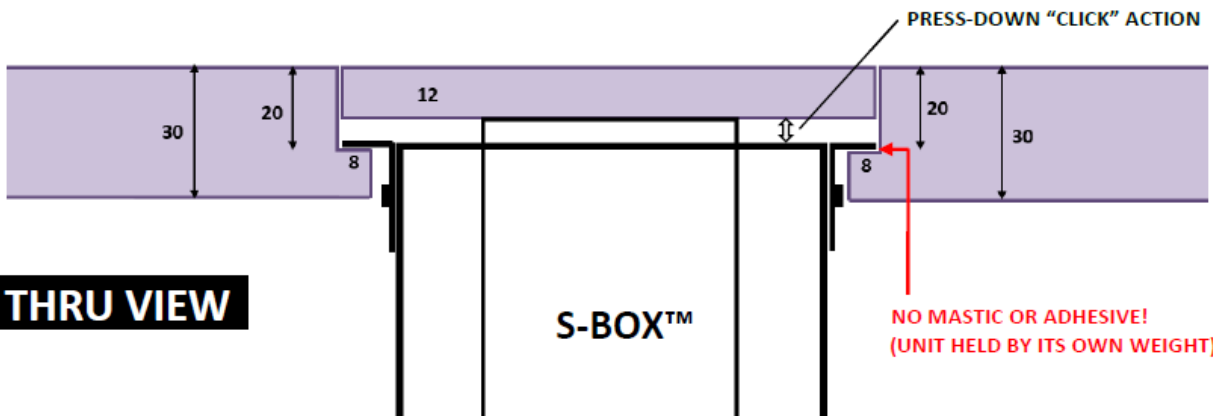
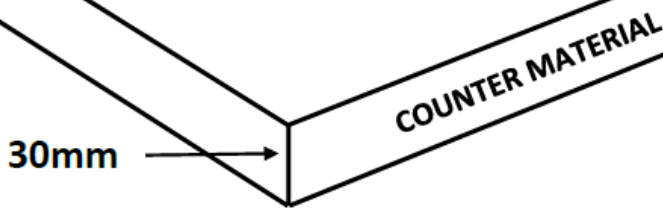

THRU VIEW

S-BOX™

NO MASTIC OR ADHESIVE!
(UNIT HELD BY ITS OWN WEIGHT)

30mm



“TRUE” REBATE FOR INSTALLING AN S-BOX™ CHAMELEON UNIT IN 30mm COUNTER-TOP



3-PORT



KEY DIMENSIONS

NB. THIS DIAGRAM DOES NOT SHOW RADIUS CORNERS FROM CUTTING PROCESS OR TOOLS BECAUSE THEY CAN BE ANY RADIUS PREFERRED. (as long as custom top fits inside radius of Cut-hole)

Matching thin stock or Sliced down from Offcut material ↓



CUSTOM TOP
10-12mm (MAX)

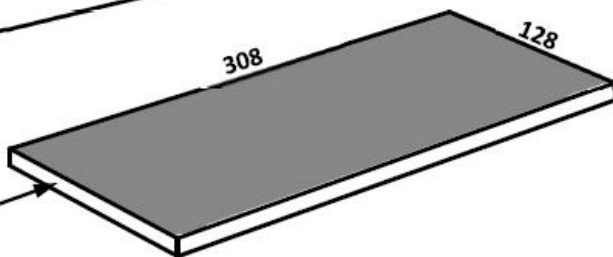

THRU CUT #1

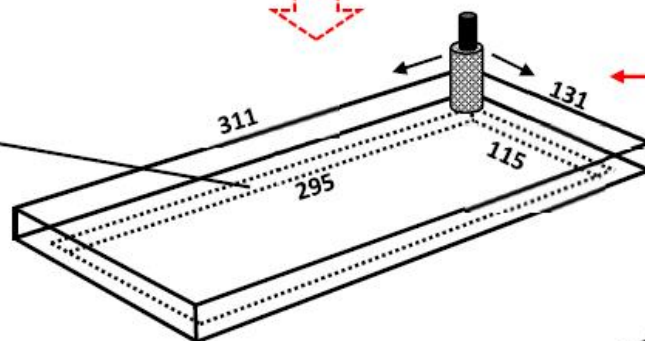

ROUTED EXTRA 8mm ALL ROUND

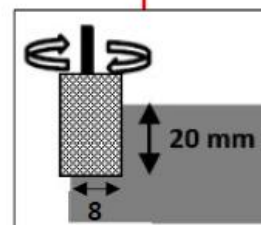

COUNTER MATERIAL

30mm



THRU VIEW

S-BOX™

NO MASTIC OR ADHESIVE!
(UNIT HELD BY ITS OWN WEIGHT)

CREATING THE REBATE WITH 20mm MATERIAL REQUIRES THE USE OF A SECOND/"SLAVE" PLATE. THE DIFFERENCE BETWEEN THE UPPER HOLE DIMS, AND THOSE OF THE SLAVE, CREATES THE REBATE. CUSTOM TOP DIMENSIONS ARE 3mm SMALLER, TO PRODUCE A 1.5MM GAP TO ALL 4 SIDES.

20mm

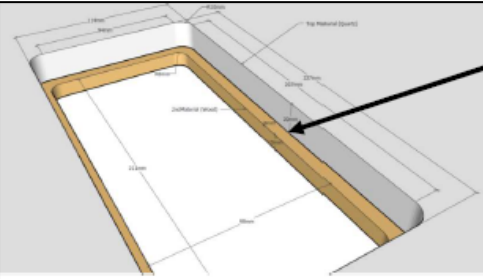

"FALSE REBATE" FOR INSTALLING AN S-BOX™ CHAMELEON UNIT IN 20mm QUARTZ COUNTER-TOP.

NB. THIS DIAGRAM DOES NOT SHOW RADIUS CORNERS FROM CUTTING PROCESS OR TOOLS, BECAUSE THEY CAN BE ANY RADIUS PREFERRED. (as long as custom top fits inside radius of Cut-hole)

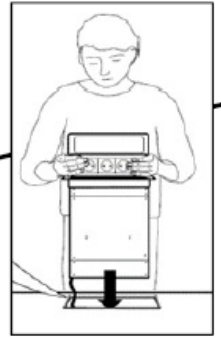

2-PORT MINI

KEY DIMENSIONS



CUSTOM TOP

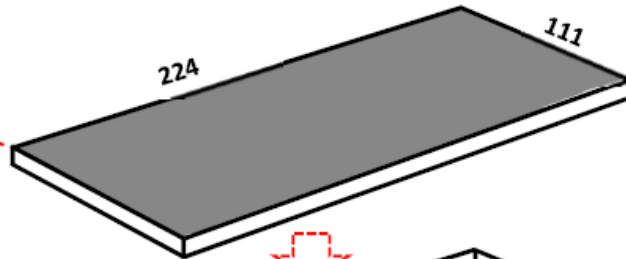

10-12mm (MAX)

Sliced down from thicker material ↓

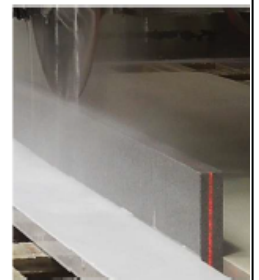

CUT-OUT HOLE

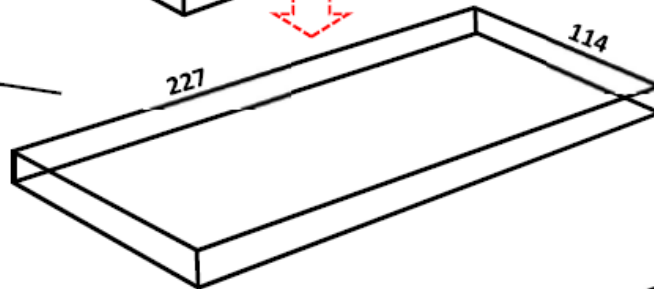

COUNTER MATERIAL

20mm

"FALSE REBATE" PLATE BONDED UP TO COUNTER MATERIAL

12mm (or any suitable off-cut material between 10-20mm)

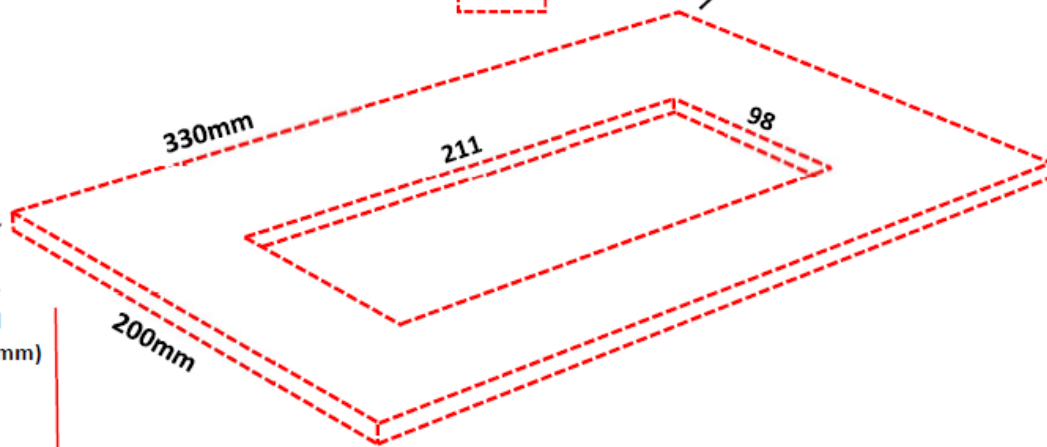

PRESS-DOWN "CLICK" ACTION

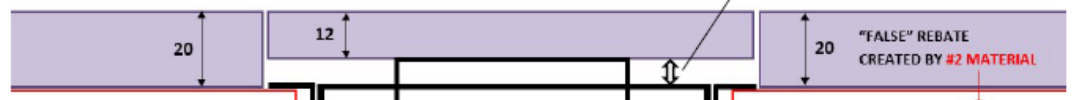

THRU VIEW

S-BOX™

12mm

"FALSE REBATE" FOR INSTALLING AN S-BOX™ CHAMELEON UNIT IN 12mm COUNTER-TOP MATERIAL

2-PORT MINI



KEY DIMENSIONS

NB. THIS DIAGRAM DOES NOT SHOW RADIUS CORNERS FROM CUTTING PROCESS OR TOOLS, BECAUSE THEY CAN BE ANY RADIUS PREFERRED. (as long as custom top fits inside radius of Cut-hole)

Tops are made from spare 'off-cut' 12mm material ↓

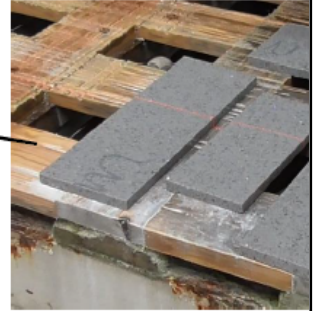

CUSTOM TOP
12mm

CUT-OUT HOLE

12mm

COUNTER MATERIAL

"FALSE REBATE" PLATE
BONDED UP TO COUNTER MATERIAL
(S-BOX™ COLLAR SITS ON ITS REBATE)

ROUTED 8mm x 8mm REBATE

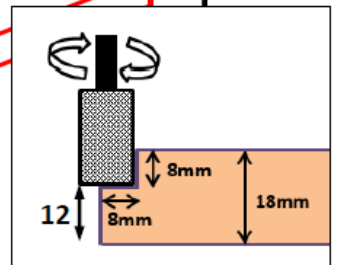

12 or 18mm

200mm

330mm

227

211

114

98

PRESS-DOWN "CLICK" ACTION

THRU VIEW

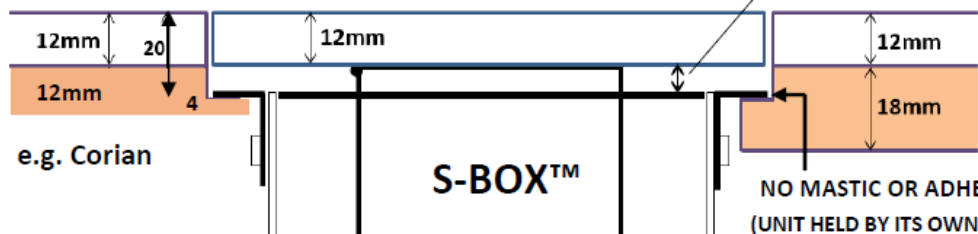

12mm

"FALSE REBATE" FOR INSTALLING AN S-BOX™ CHAMELEON UNIT IN 12mm COUNTER-TOP MATERIAL

3-PORT



KEY DIMENSIONS

NB. THIS DIAGRAM DOES NOT SHOW RADIUS CORNERS FROM CUTTING PROCESS OR TOOLS, BECAUSE THEY CAN BE ANY RADIUS PREFERRED. (as long as custom top fits inside radius of Cut-hole)

Tops are made from spare 'off-cut' 12mm material ↓



CUSTOM TOP
12mm

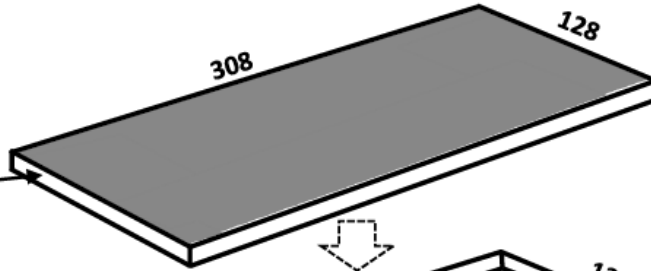

CUT-OUT HOLE

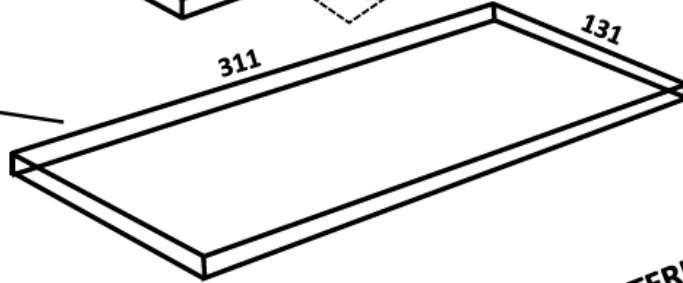

COUNTER MATERIAL

12mm

"FALSE REBATE" PLATE

BONDED UP TO COUNTER MATERIAL
(S-BOX™ COLLAR SITS ON ITS REBATE)

ROUTED 8mm x 8mm REBATE

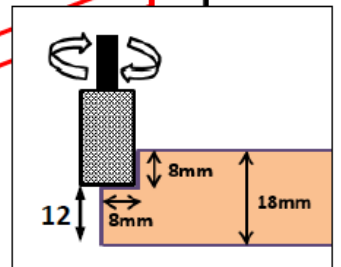

12 to 18 mm

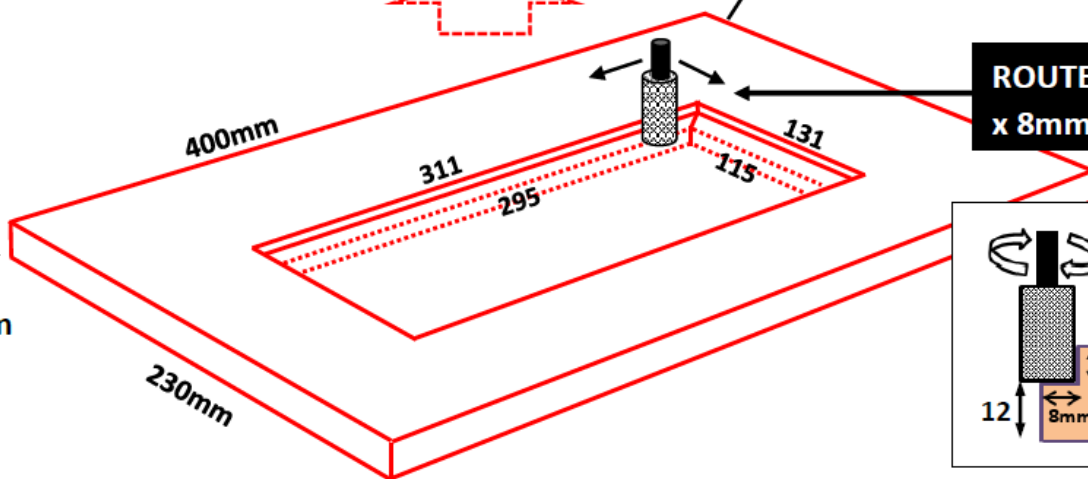

THRU VIEW

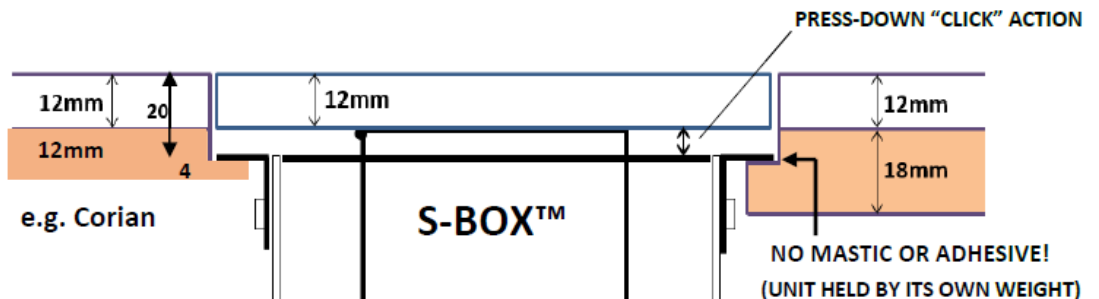

THE CUSTOM TOP

THE 12mm (maximum) S-BOX™ CUSTOM TOP IS MADE BY 'SLICING' AN OFF-CUT PIECE OF THE COUNTER MATERIAL OR CAN BE MADE FROM 12mm MATCHING STOCK.

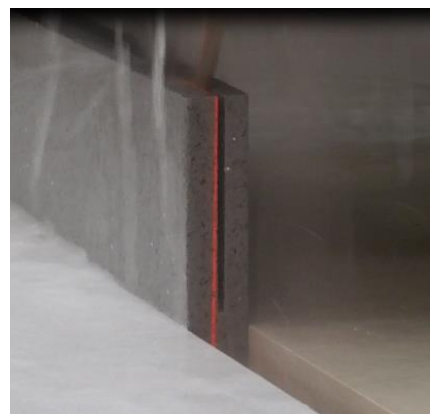
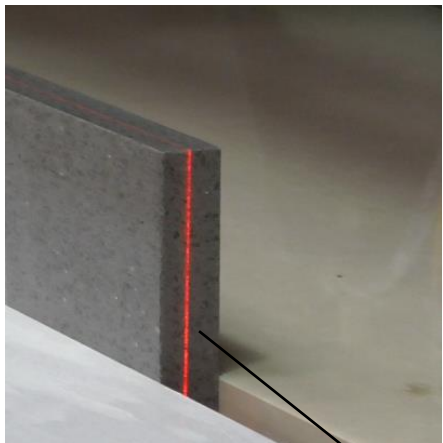

THE CIRCULAR SAW FOLLOWS A LASER LINE, AND CAREFULLY CUTS THE THICK MATERIAL DOWN INTO THE 12mm THICKNESS REQUIRED. THIS IS DONE IN A SERIES OF 8-10 PASSES TO ENSURE THE INTEGRITY OF THE STONE.

CROSS-CUTTING CREATES THE FINAL SIZES READY FOR THEIR CORNERS TO BE ROUNDED



THE CORNERS ARE TYPICALLY ROUNDED BY HAND TO ENSURE THAT THE CUSTOM TOPS WILL NEATLY MARRY WITH THE INTERNAL RADIUS OF THE HOLES. THE EXPERIENCE AND SKILL OF THE WORKTOP SUPPLIER ENSURES THAT EVERYTHING WILL FIT BEAUTIFULLY ON SITE.



WITH 20mm REBATE HOLE AND TOP NOW READY, THE COUNTERTOP CAN GO TO SITE FOR THE S-BOX™ UNIT TO BE INSTALLED! 😊

ON SITE CROSS-CHECK

THE 20mm REBATE

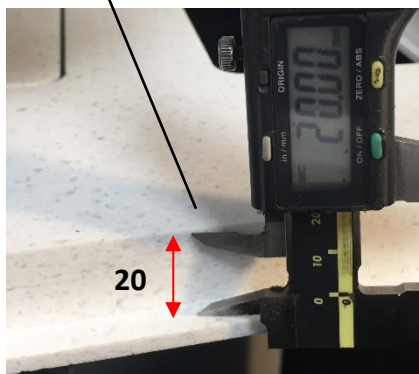

THE COLLAR IS ADJUSTABLE TO ENSURE THAT THE UNIT AND ITS TOP ARE "4-SIDE PARALLEL" & FIT INTO THE 20mm REBATE

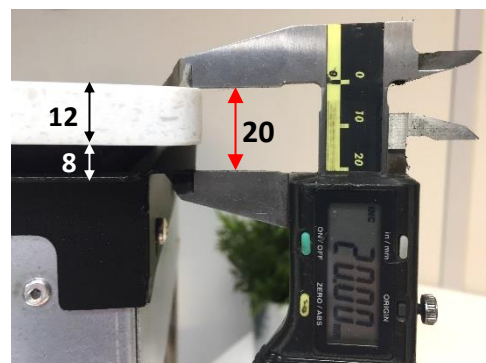

Please set this (if necessary) before installation

ON SITE LIFT-ADJUSTMENT – FOR ALL UNITS

ALL S-BOX™ UNITS FEATURE A PATENTED & ADJUSTABLE “ZERO-ENERGY” LIFT SYSTEM

This is actually a counterbalance, operating in its own lift-shaft, and which is released to work by way of the catch. Based on the weight of the custom top material, and before the unit is installed into its rebate, this counterbalance will require subtraction or addition of weight for the individual unit to operate correctly.

To do this, place the Custom Top temporarily on top of the box >

Then open the front plate as shown below: ↓



You **MUST** now add the required amount of extra weight into the weight tray, until you are happy with its pace of lift (ahead of the new top being added more permanently later). Refasten the door.



A PACK OF COUNTERWEIGHTS HAS BEEN PROVIDED, SO THAT THE DENSITY OF ANY 12mm “CUSTOM TOP” MATERIAL CAN BE OFFSET TO ESTABLISH THE UNIT’S SELF-LIFT.

PLEASE ADD WEIGHTS AS FOLLOWS:

- 12mm CORIAN® - Add 0-2 additional weights
- 12mm QUARTZ - Add 4-8 additional weights
- 12mm GRANITE - Add 6-10 additional weights
- 12mm DEKTON® - Add 10-12 additional weights

NB. These Counterweights are SQUARE for 3-PORT and RECTANGULAR for MINI (as above)

You can now introduce the S-Box™ unit into its rebated hole.

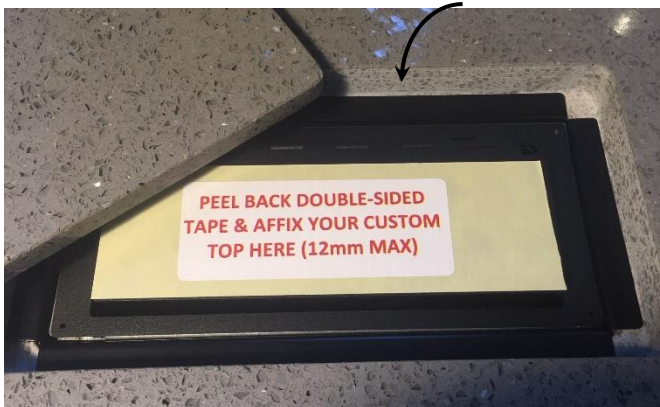

NB. If your Top is lightweight material (such as Timber) there are weight strips that can be removed from the weight tray instead.

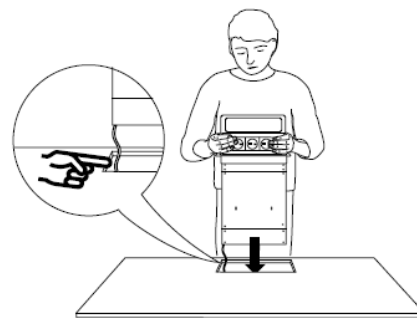

 The black collar is perfectly OK on its own, and is deliberately designed to suit nil or very tight radius corners from the cutting process

As an option, specifically for fuller radius corners (8mm+), a Steel drop-in cover plate is provided, to fill in the corner curves of the rebate.



For lightweight materials that are dry and free from dust, (like Timber or Corian) peel back the tape and place the custom top into position. Press it firmly home. Allow 12hrs for adhesive to bond and cure.

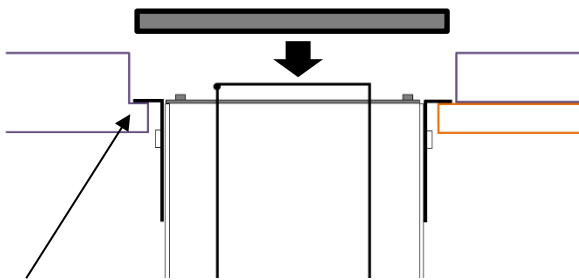

***PLEASE NOTE * ↓**

FOR STONE (GRANITE and QUARTZ) AND DUSTY MATERIAL PLEASE ALSO ADD 3-4 OF SPOTS OF SILICON or ADHESIVE TO THE STEEL LID FOR EXTRA SECURE ADHESION.



*** DO NOT USE ANY MASTIC OR ADHESIVE HERE. UNIT MUST BE REMOVEABLE IF REQUIRED. IT USES ITS OWN WEIGHT FOR STABILITY.**

THE COMPLETED UNIT SHOULD NOT BE PERMANENTLY FIXED INTO ITS REBATE. ITS OWN WEIGHT WILL KEEP IT IN POSITION. THIS ENSURES THAT IN THE EVENT OF A SPILLAGE OR IF THE UNIT NEEDS TO BE EXTRACTED FOR ANY REASON IT CAN BE LIFTED OUT THROUGH THE SURFACE AND RETURNED TO ITS REBATE (AFTER CLEANING OR AFTER ADJUSTMENT etc.)

**** It is Ok to use a couple of small dabs of mastic below the collar but unit must still be able to be extracted ****

Any final "fine-tuning" of levels, if still required, can be achieved by adjusting the internal catch's male ball position, so that in the closed (*catch-engaged*) position, the Custom Top and the adjacent surface are perfect and level.

By twisting the threaded ball part, and holding the top nut, the position of the ball can be raised or lowered by the tiniest of amounts. This can be found inside the base unit.

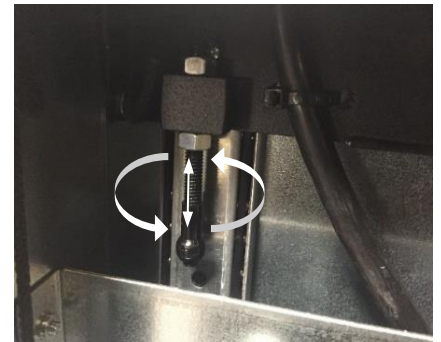
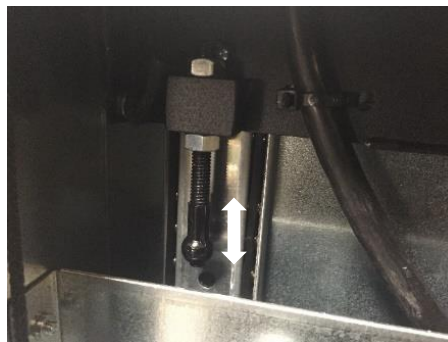

All S-Box™ products are complete sealed units with a 2.4m cable for connection to mains power via a junction box. This cable can also receive a simple plug if preferred! All electrical connections should be carried out by a fully Qualified Electrician

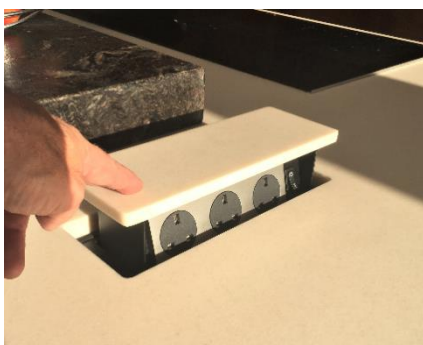

S-Box™ is a registered trademark of Cardinal IP Limited
The S-Box™ product innovation is protected by Patents - registered to Cardinal IP Limited

Cardinal Innovations Limited

Battye Street, Bradford, West Yorkshire, ENGLAND BD4 8AG

Tel: +44 (0)1274 386820 Email: sales@the-sbox.com Web: www.the-sbox.com