

Sink Foster Milano

Kitchen Sinks

Code: 1015 850



DETAILS

Edge/Installation Type	Undermount
Finish	Foster brushed
Material	AISI 304 stainless steel
Texture	Brushed in line
Base	120 cm
Dimensions	1016x500 mm
Standard fittings	Fixing hooks, gasket, drain, overflow and siphon, boxed packing
Mixer holes	No standard holes
Built-in hole	968x452 mm

Drainer No

Width 102 cm

Bowl dimension 968x400mm

Number of bowls 1 bowl

Waste fitting 3,5" drain

FEATURES

Diamond-shape bottom The draining of water is an important feature in a sink, and it's always taken good care of in Foster products. In the bent-welded sinks, which would have a flat bottom, the proper draining is guaranteed by the elegant beveling, which helps the water flow.

High thickness 1mm thick steel. A significant thickness, which guarantees the maximum sturdiness and durability.

Perimetral overflow The overflow is always a security on the Foster sinks that prevents the overflow of water in case of oversights. The perimeter drain solution improves aesthetics thanks to its square and essential shape.

Save space system Drain and siphon are designed to leave as much space as possible in the under-sink area, more and more useful today for theseparate waste collection systems.

Space waste fitting The elegant SPACE steel cap closes the drain and leaves no visible residues collected in the basket below. Space also has a small footprint and allows the optimal use of the under-sink compartment.

Triple recess - sliding accessories The Foster Milano sink has an ingenious design that makes it simple to use a large set of optional accessories. On the topmost supporting step, the innovative Black grids slide, creating a large and practical surface to rinse food and crockery. The second step is meant to support and allow the sliding of a complete combination of accessories, which make some operations practical and safe: rinse, drain, slice, grate... everything can be done inside the sink. The third supporting step is on the bottom of the bowl. On this step one can rest the Black grids, making it possible to rinse foodstuffs without their coming in contact with the bottom of the sink, which may be dirty.

TECHNICAL DATA

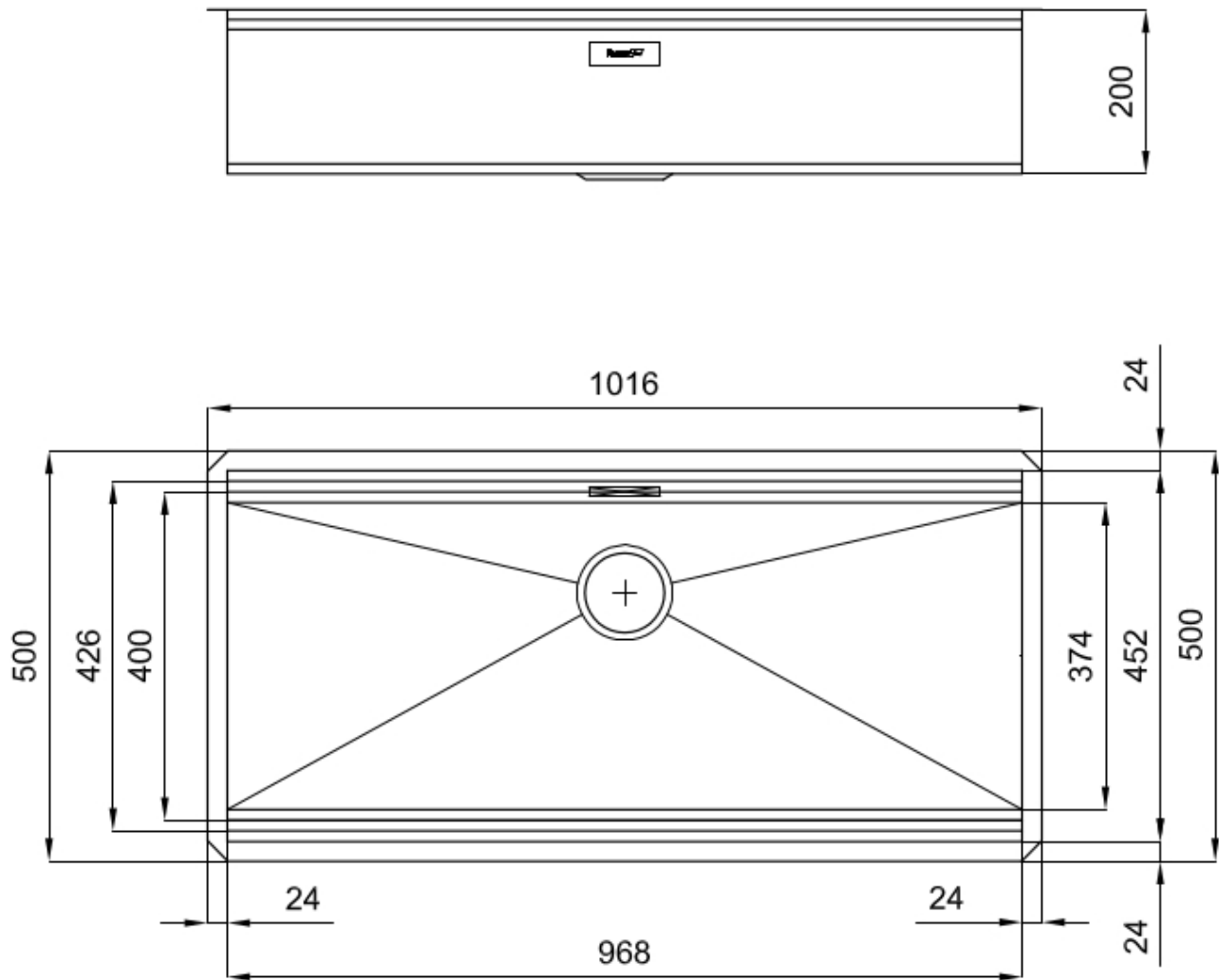

Milano Optional accessories / Accessori opzionali

The "rails" system makes it possible to use a combination of numerous accessories. Grids, chopping boards, utensils' ranging system, bowls and containers of different dimensions can be alternated in the workspace with a simple gesture, and can easily be stacked, in order to be on hand at all times.

Il sistema di "corsie" rende possibile l'utilizzo combinato di innumerevoli accessori. Griglie, taglieri, portautensili, vaschette e contenitori di varie dimensioni si alternano nella zona di lavoro con un semplice gesto e possono essere impilati, sempre a portata di mano.

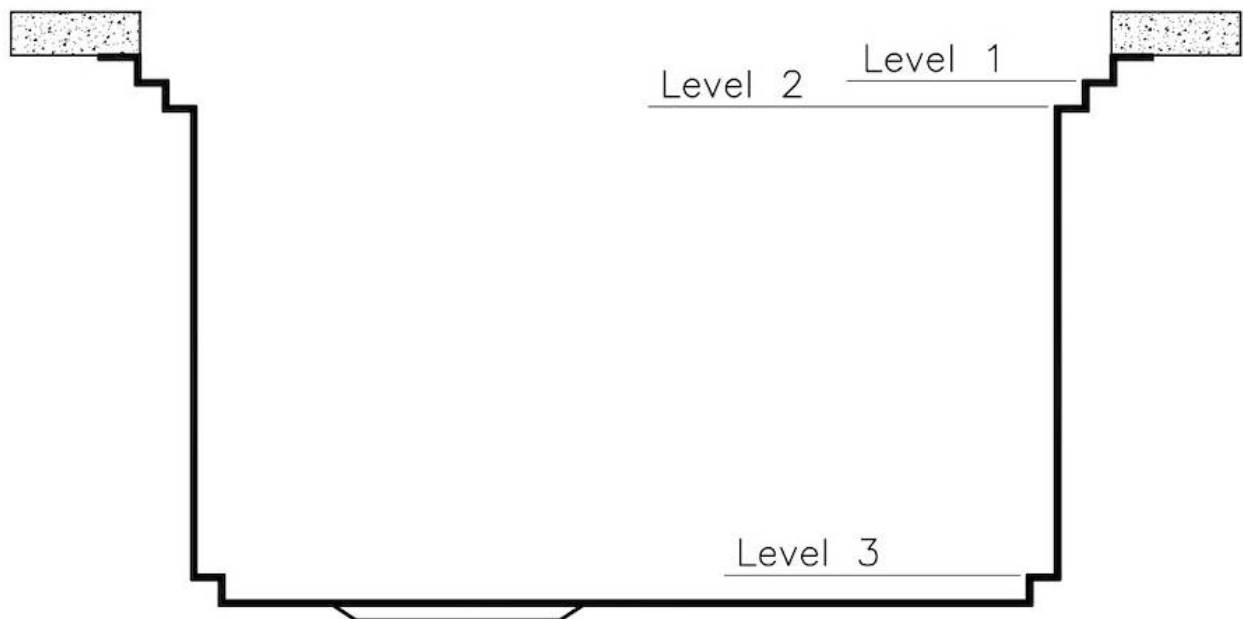

Milano Level 1

Compatible accessories/Accessori compatibili:

8100 600

8642 000



Milano Level 2

Compatible accessories/Accessori compatibili:

8153	100
8631	300
8644	101



Milano Level 3

Compatible accessories/Accessori compatibili:

8100 600



GALLERY



OPTIONAL ACCESSORIES



Black grid



Glass chopping board



HPDE Twin chopping board



Stainless steel plate rack



Walnut-wood chopping board



Graters kit with ring-holder and food collection tray



Stainless steel perforated tray

WARNING:

The accessories 8159101, 8100303,8151000 are only usable in combination with 8644101

RECOMMENDED PAIRINGS



Cooker hob Foster Milano



Mixer Tap FL

OPTIONAL AUTOMATIC WASTE FITTINGS



Automatic waste fitting



Space automatic waste fitting



Space automatic waste fitting



Space Light automatic waste fitting



Space Milano automatic waste fitting



Space Push automatic waste fitting